

KCN-4S/6S

OPERATIONS MANUAL

Thank you for choosing Koyo's single preset addition/subtraction counter for your control needs. Please read through this manual before using your new counter.

Koyo Electronics (Wuxi) Co.,LTD.

Add: 21st Floor, Building 1, No.599, Jianzhuxi Road, Binhu District, Wuxi, Jiangsu, P.R.China
 Pc: 214072 Tel: (0510)85167888 Fax: (0510)85161393
 KEW-M8372B-E

Panel functions

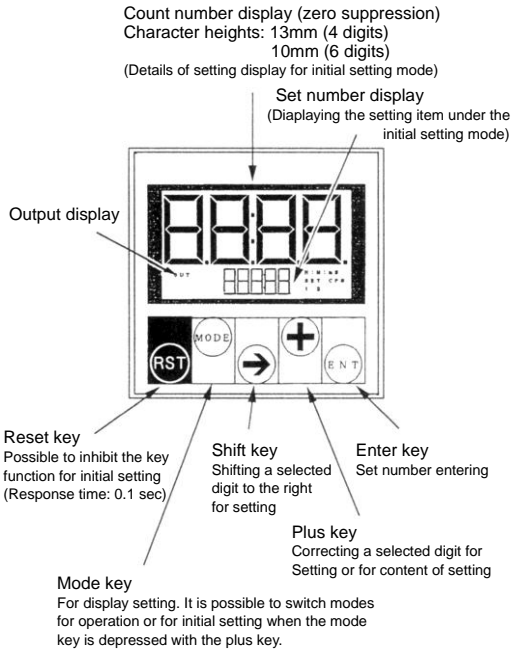

Specifications

Item	Specifications
Feature	Addition/Subtraction counter and timer (4 digits)
Setting	Single preset(dual preset only for one-shot timer operation)
Digit number	4 and 6 digits (2 models)
Count input	Count speed: 30/1k/2k/5kHz switching type (Refer to "count timing" for phase difference and duty.) Input impedance: 15kΩ (positive logic) 3.3kΩ (negative logic) Input voltage: 0~3V (L), 7~30V (H)
Start input (For timer function)	Input response: 15ms(on-delay only for timer) 15ms(off-delay)
External Resetting	Input response: 5ms(on-delay) 5ms(off-delay) Input impedance: 15kΩ (positive logic) 3.3kΩ (negative logic) Input voltage: 0~3V (L), 7~30V (H)
Manual resetting	Input response: 0.1 sec
Automatic resetting	500μs (2.5ms for 5kHz count speed)
Power source resetting	Shutdown time: 1 sec Reset time: 1 sec
Output	Transistor NPN open collector output 24V,100mA output: Withstanding voltage 35V Residual voltage Less than 2V Contact Normally open contact 220VAC,2A output: (resistive load)
Output operation	Counter output One shot/retention Timer output On-delay/off-delay/one shot/flicker/integration
One-shot time	10ms~990ms
Prescale	0.001~9.999 (4 digits) 0.001~99.999 (6 digits)
Decimal point	Free setting at any point
Power source	AC type: 85~115/180~240VAC Power consumption 5VA DC type: 20~28VDC, Power consumption 2W
Power source for sensor	20~28VDC, 15mA (accessible only for AC-type models)
Weight	About 220g (AC type) About 110g (DC type)

Count timing

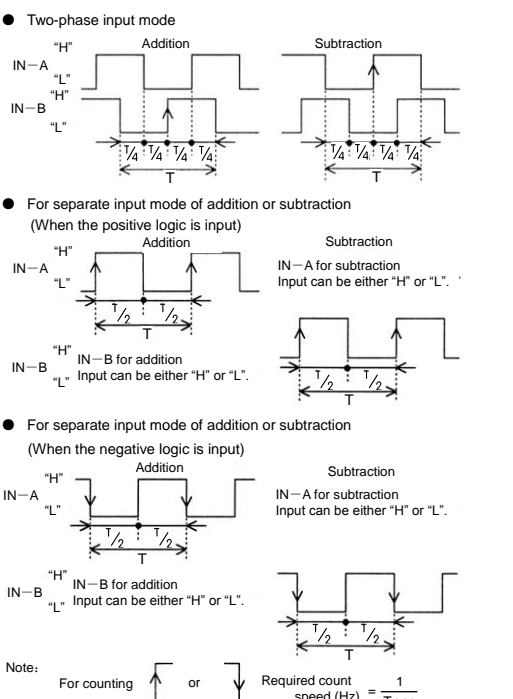

Key operation

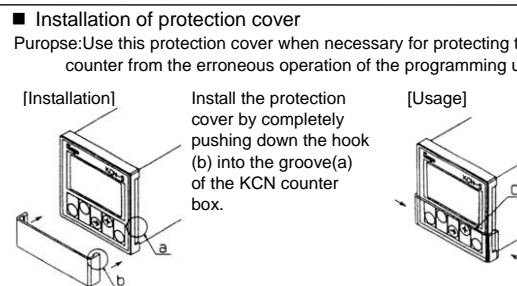
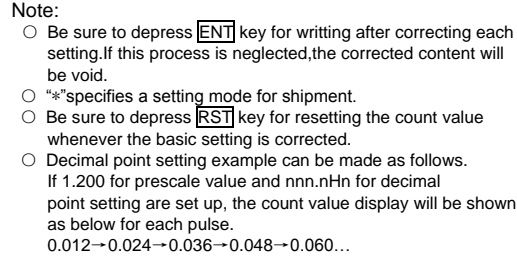
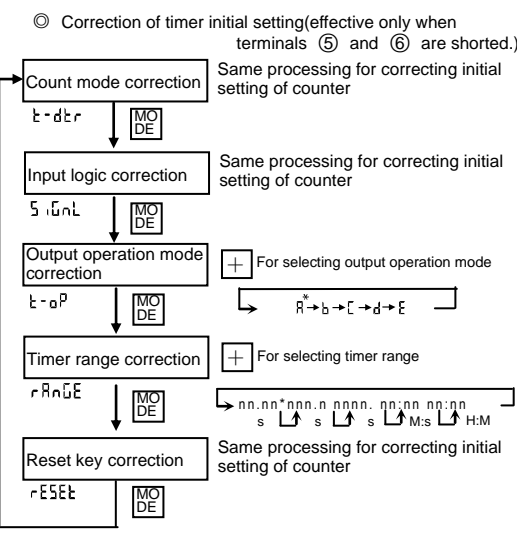
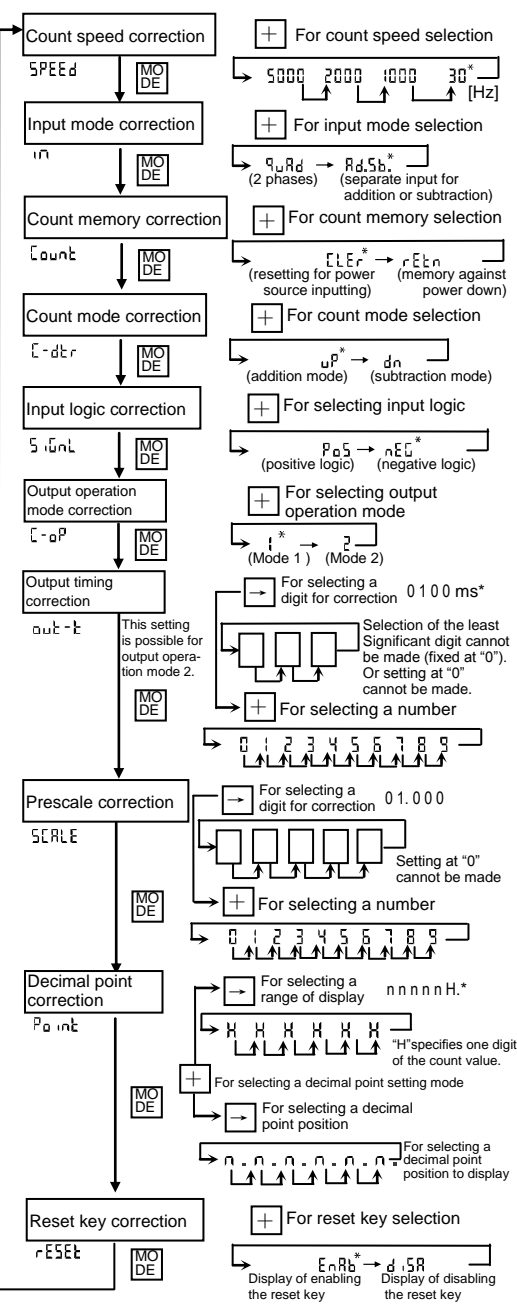
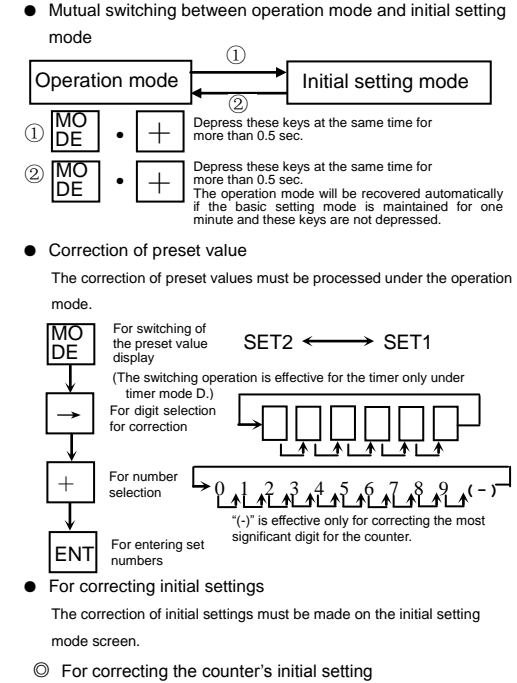

Counter output operation mode

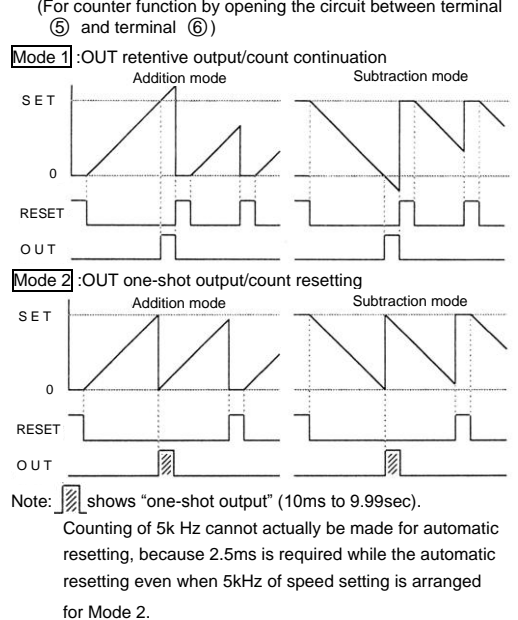

Timer output operation mode

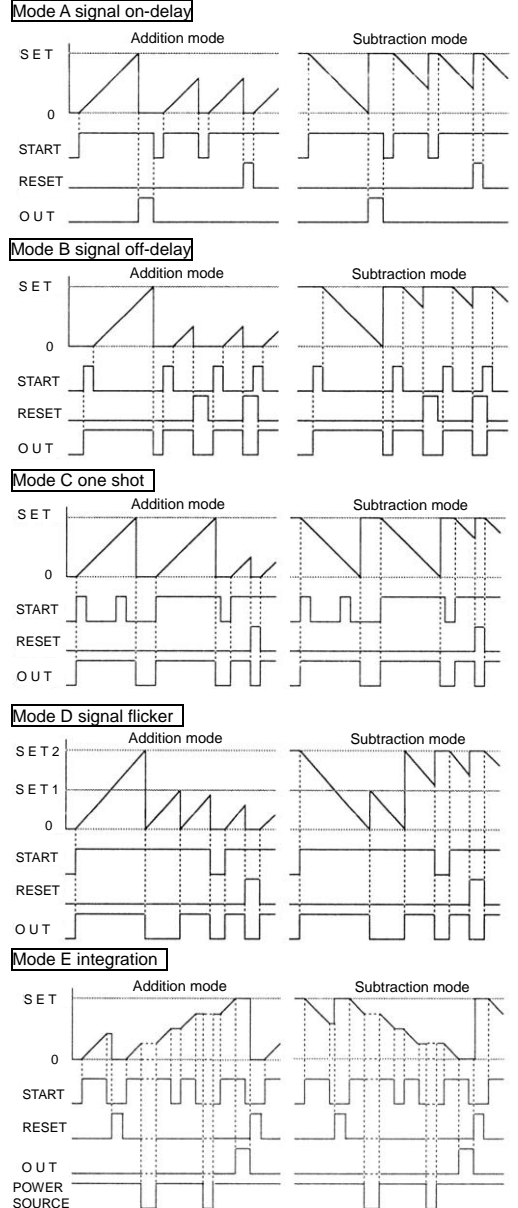

Caution

- The 0V terminal (3) for DC-type counters of power supply and the input common (0V) terminal (5) are connected in the counter.
- The power source voltage should be instantly applied for the rated voltage by the switch or relay instead of a gradual voltage increase.
- Use the counter with no voltage setting for input logic if the DC 2 wire type of proximity switch is included.
- Be sure to reset the count value by depressing a reset key whenever the initial setting is corrected.
- Turn on the power source after connecting the input (sensor use power source) common terminal (5) with the counter/timer switching terminal (6) if this model is used as a timer.
- If this model is used as a timer (4-digit display only), the preset error will be shown for changing the display from seconds (S) to minutes (M) and seconds (S) or to hours (H) and minutes (M), when the preset number of the second digit from the right is more than six. It is necessary to correct the preset in advance.
- Be sure to correct the initial setting and preset value when this model is going to be used as the counter after being used as the timer.
- The correction of the preset value in the middle of counting will be effective from the time when ENT key is depressed.
- Be sure to keep the initial setting and preset value in memory for maintenance.
- Avoid using this model under the following conditions:
 - Where the ambient temperature exceeds a range of -10°C to 50°C.
 - When the ambient humidity exceeds 85% RH or when dew condensation will result from a sudden change in temperature.
 - Where dust, iron powder, or corrosive gas is present.
 - In direct sunlight.
 - Where it will be subject to excessive vibration or shock.
- Observe the following conditions for wiring:
 - The wiring should be separated from the power line.
 - When this model is used in an area in which much noise is generated, try to separate the main unit and wiring as far as possible from the source of the noise.
 - The terminal not in use should not be used for other units or purposes.
- Be sure to separate this model from the control circuit for dielectric strength and insulation resistance tests.

Terminal connection

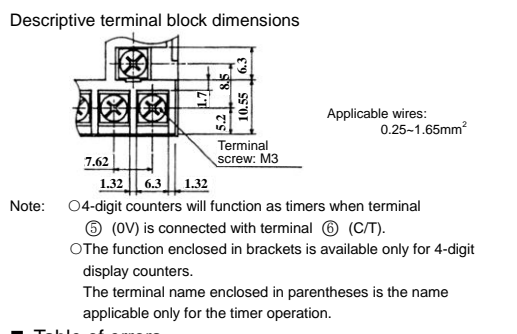
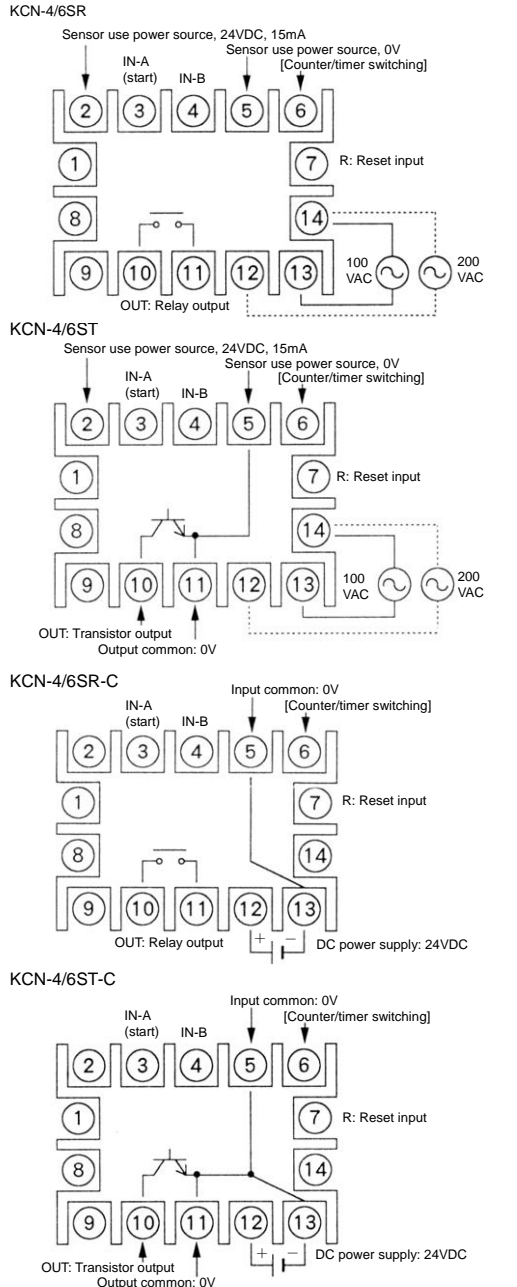

Table of errors

Display	Description
Count number	Preset number
FFFFF	Preset number
- FFFFF	Preset number
PSET	Reset value memory data error
PSET2	Errors for exceeding a range of internal counting when the preset value is divided by the prescale value with classification of "1" or "2"
PSET11	Errors for exceeding a range of internal counting when the preset value is divided by the prescale value with classification of "1" or "2"
SPEED	Count speed memory data error
C-oP	Output operation mode memory data error
out-t	Output time memory data error
SCALE	Prescale memory data error
PoInt	Decimal point memory data error
t-oP	Timer output operation mode memory data error
rANGE	Timer range memory data error

Note: * The memory data error will be generated whenever the setting data change to the unrealistic data.

How to release from the error condition

Depress **RST** key for counter overflow or underflow to reset the counter. Or release the error display when the count number returns to the number within a range of the display. Depress **ENT** key for other setting errors to delete the error display. The error will be released when the correct setting number is then input.

Note:

- The counter is correctly counting numbers within a range of -2147483.648 to 2147483.647 in the counter, even when a counter overflow or underflow error is generated.
- The error will be checked when the power source is turned on. The counting or outputting operation will not be made except during an overflow or underflow of the counter.

